

MARCUS

3586461



**Garden
Lights**

MARCUS

3586461



Dit product bevat een lichtbron van energieklasse

This product contains an energy class light source

Dieses Produkt enthält eine Lichtquelle der Energieklasse

Ce produit contient une source lumineuse de classe énergétique

A++

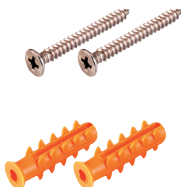

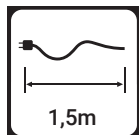
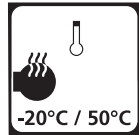
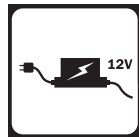

Warm-koud lichtschakelaar / Warm-cold light switch / Warm-Kalt Lichtschalter /
Interrupteur d'éclairage chaud-froid



Zet schakelaar om naar gewenste lichtkleur.

Set switch to desired light color.

Stellen Sie den Schalter auf die gewünschte Lichtfarbe.

Réglez le commutateur sur la couleur de lumière souhaitée.

Montage steker / Plug mounting / Steckermontage / Montage par fiche



Gebruik van de spies in vaste grond.

Using the skewer in solid soil.

Verwenden Sie den Spieß in festem Boden.

Utilisation de la brochette dans un sol solide.

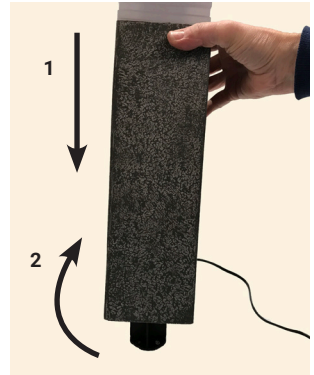
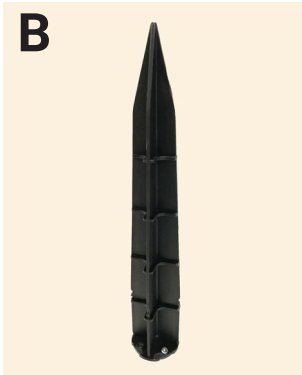

Gebruik van de spies op bijv steen of hout. Bevestig steker met minimaal 2 schroeven op de ondergrond. Draai lamp met de klok mee.

Use of the skewer on, for example, stone or wood. Attach the plug to the surface with at least 2 screws. Turn lamp clockwise.

Verwendung des Spießes zum Beispiel auf Stein oder Holz. Befestigen Sie den Stecker mit mindestens 2 Schrauben an der Oberfläche. Lampe im Uhrzeigersinn drehen.

Utilisation de la brochette sur pierre ou bois par exemple. Fixez la fiche à la surface avec au moins 2 vis. Tournez la lampe dans le sens des aiguilles d'une montre.

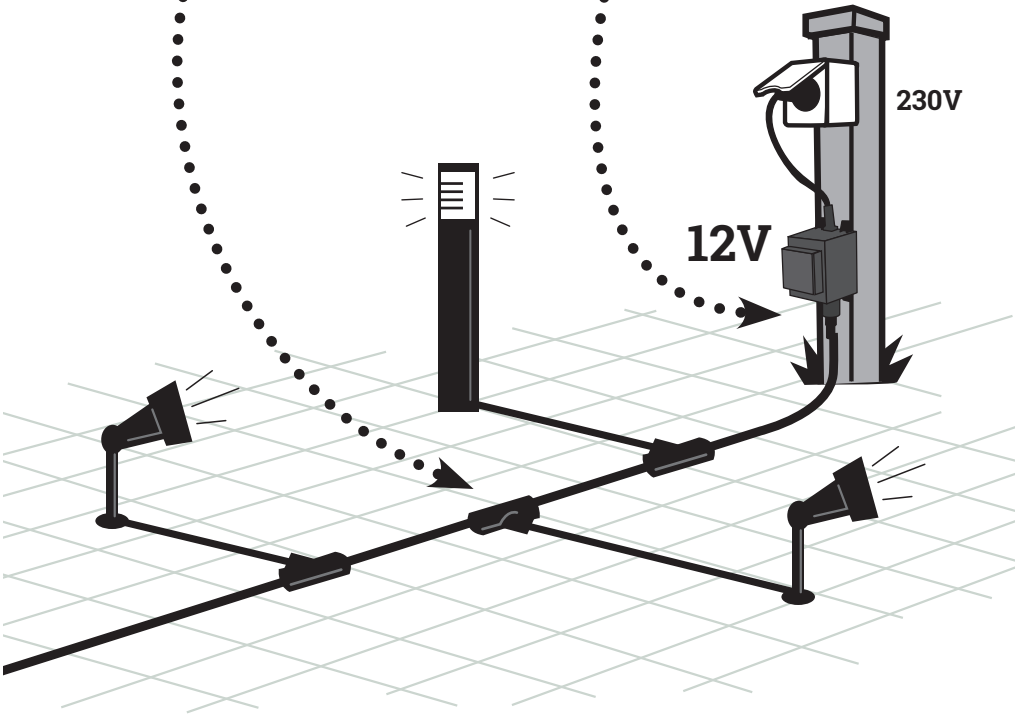
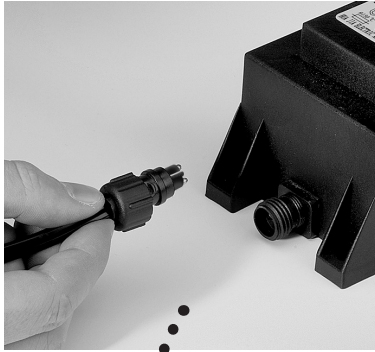
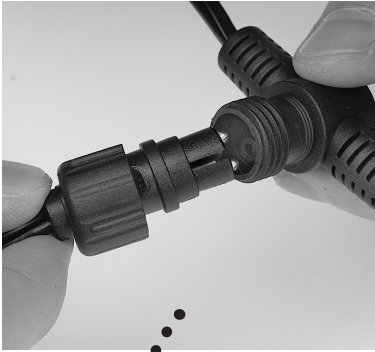



NL - Dit product voldoet aan de EU-normen voor gezondheid, veiligheid en milieubescherming.

EN - This product meets the EU standards for health, safety and environmental protection.

DE - Dieses Produkt entspricht den EU-Standards für Gesundheit, Sicherheit und Umweltschutz.

FR - Ce produit répond aux normes de l'UE en matière de santé, de sécurité et de protection de l'environnement.



NL - Afgedankte elektrische apparatuur mag niet in het huisvuil terecht komen. Breng, indien mogelijk, deze apparaten naar een recyclingbedrijf. Voor informatie over recycling kunt u terecht bij een gemeentelijk afvalverwerkingsbedrijf of bij uw dealer.

EN - Discarded electrical equipment must not be put in the household waste. If possible, take it to a recycling company. For details of recycling, contact a municipal waste processing company or your dealer.

DE - Entsorgen Sie elektrische Geräte nicht im Hausmüll. Nutzen Sie die Sammelstellen in ihrer Gemeinde. Fragen Sie Ihre Gemeindeverwaltung nach den Standorten der Sammelstellen.

FR - Ne pas jeter les équipements électriques usagés dans la poubelle domestique. Si possible, remettez-les à une entreprise de recyclage. Pour tout détail concernant le recyclage, contactez un organisme municipal de traitement des déchets ou votre revendeur.

NL - 3 jaar garantie – bezoek onze website garden-lights.com voor de garantievoorwaarden

EN - 3 year warranty – visit our website garden-lights.com for warranty conditions

DE - 3 Jahre Garantie – Besuchen Sie unsere Website garden-lights.com für die Garantiebedingungen

FR - Garantie de 3 ans – visitez notre site web garden-lights.com pour les conditions de garantie

NL - Voor vragen over onderdelen, service, eventuele klachten of andere zaken kunt u altijd bij ons terecht. E-mail: info@garden-lights.com.

EN - For questions about parts, service, any complaints or other matters, you can contact us at any time. E-mail: info@garden-lights.com.

DE - Wenn Sie Fragen zu Einzelteilen oder zum Service haben, oder wenn Sie uns eine Beschwerde oder andere Hinweise übermitteln möchten, können Sie sich jederzeit an uns wenden. E-Mail: info@garden-lights.com.

FR - Pour tout renseignement concernant les pièces de rechange et les réparations ou pour les éventuelles plaintes et autres problèmes, n'hésitez pas à nous contacter à l'adresse suivante: info@garden-lights.com.

**Garden
Lights**

WWW.GARDEN-LIGHTS.COM